

Real Time Monitoring and Simulation Analysis of 30WP off Grid Solar Rooftop Photovoltaic Power Plant

Jayanna Kanchikere¹, K. Kalyankumar²

¹Research Scholar,

Vinayaka Missions Sikkim University, East Sikkim, INDIA

²Former Vice-Chancellor,

Vinayaka Mission Sikkim University, East Sikkim, INDIA

Abstract— Energy demand in Telangana state is increasing, however the electric utilities failed to meet this load demand. Photovoltaic (PV) solar power plant is used for larger development of solar power generation. In a solar roof top system, the solar panels are installed on the roof of any residential, commercial, institution and industrial building. The solar roof top system may come up with storage facility using battery or grid connected. The roof top system with storage facility has a battery to store solar electricity and can be utilized during night when sunlight is not available. In this research paper, real time monitoring and Simulation analysis of 30WP off grid connected photovoltaic solar roof top power plant at Hyderabad city is carried out using software PV Syst. The real time results of PV module and simulation results of energy output of PV module, energy supplied to load and unused energy are presented.

Keywords— Grid; Roof top system; solar photovoltaic panel; solar radiation

Introduction

Telangana state being located between 15° 54' and 19° 37' North latitude and the geographical location favors the harvesting and development of solar energy. Telangana state is having good solar radiation of 4.9 KWh/square-meter 333/day. Hyderabad city comes under Telangana state in India. The yearly average solar radiation on horizontal surface is 4.9 KWh/m²/day at latitude of 17.4 °N and longitude of 78.5 °E [8].

In isolated regions and because of the scarcity of means, it is necessary to optimize the solar off-grid (stand-alone) PV system in order to minimize the costs and to make the PV systems competitive with the other forms of renewable energies. Modeling and simulation techniques can be used to assess the performance of PV system components before installation in place hence reducing the overall system cost[2].

Electric utilities are finding it difficult to meet rise in peak demand and as a result, most of cities and towns are facing severe electricity shortages. Most of commercial establishments use one or more diesel generator for back-up

power. In order to utilize the existing roof space of buildings, the scheme proposes to promote rooftop solar PV systems on buildings to replace diesel generator sets [5].

OFF GRID / Standalone ROOF TOP SOLAR POWER PLANTS

Solar PV cells converts sunlight to generate electricity through a photovoltaic process. There are two types of solar PV systems: standalone and grid connected. Standalone solar PV systems work with batteries [6].

In off Grid rooftop solar power plant, the DC power generated from solar photovoltaic (SPV) panel is converted to AC power using inverter and is fed to the load through single phase lines and at the same DC power is stored in Battery during day time and loads are served by Battery back in night hours [4].

A schematic sketch of a typical off grid solar rooftop photovoltaic power plant is shown in Fig.1

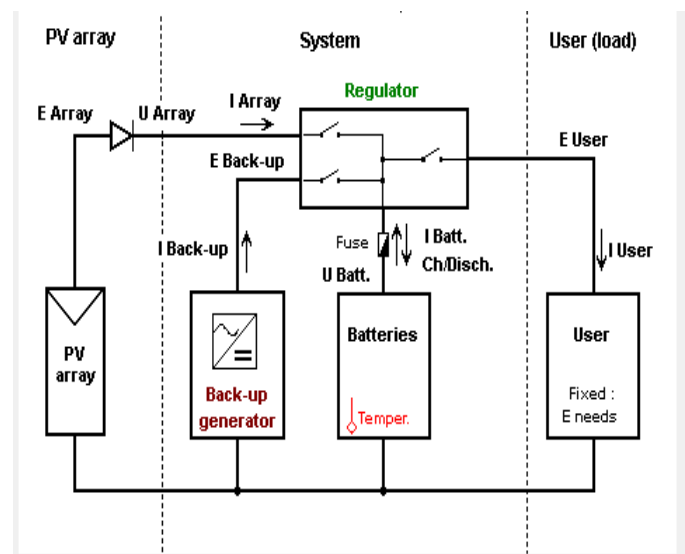

Fig1. A Schematic sketch of a Typical 30WP off Grid Solar Roof Top Photo Voltaic Power Plant.

III COMPONENTS OF SOLAR PV SYSTEM

A Grid-connected solar PV system consists of following main components [3].

A. Solar photovoltaic (PV) modules

Solar PV modules are mounted on the roof of buildings and convert sunlight into direct current. To achieve a required voltage and current, a group of PV modules are wired into large array called PV array. A 30Wp PV module is shown in Fig.2



Fig.2. A 30Wp off Grid Solar Roof Top Photo Voltaic cell

B. Solar PV array support structure

These are galvanized steel structures secure the solar PV modules on the roof of building. The mounting structures require roof to be penetrated and mounting solar panels correctly is part of maximizing power generation

C. Solar off grid inverter

Solar grid inverter converts generated direct current into alternating current which is required for all electrical appliances through a charge controller. It also regulates battery charging if required. The solar off grid inverter is shown in Fig.3



Fig.3. solar off grid inverter

D. Balance of system

All other components considered for solar rooftop power plant are cables, junction boxes, fuses etc.

The size of solar plant require depends on requirement of electrical load, number of KWh consumption.

IV REAL TIME SYSTEM DESIGN

The main target is to design and install 30WP solar rooftop solar power plant [1].

A. Key facts of solar rooftop power plant

Plant capacity in Wp : 30Wp Rooftop Solar power plant
 PV Technology/Module: Poly crystalline modules
 Power conditioning unit: 100VA
 Power evacuation : 240V Single phase, 50HZ

The real time module of 30WP Solar Roof Top Power Plant is shown in Fig. 4



Fig 4. The real time module of 30WP Solar Roof Top Power Plant

B. Number of PV panels for the system

Capacity of each module: 30WP
 Number of PV panels or modules required = 01
 Module area = 0.3 sq.m
 Nominal PV Power = 30WP
 Maximum PV Power =30Wdc
 Fixed Tilted plane = Tilt :30° ; Azimuth :0°
 The maximum power of this module is 30WP; hence it requires 01 module to design 30WP PV system. The selected PV is manufactured by Micro Sun Solar Pvt.Ltd.

The PV module parameters and ratings are given in Table 1[3].

Table1. PV module parameters and ratings

Electrical Characteristics	
Rated Maximum power (Pmax)	30Wp
Maximum power voltage (Vmp)	17.1V
Maximum power current (Imp)	1.76A
Open circuit voltage (Voc)	21V
Short circuit current (Isc)	2.02A
Maximum system voltage(Vdc)	1000V
Operating temperature	25°C

C. Solar off Grid Inverter rating

For this system, solar off grid inverter designed is 100VA is shown in Fig 2.

The inverter parameters are given in Table 2

Table 2. Inverter parameters[7]

Inverter specifications	
1-phase inverter chosen	100VA off grid inverter
Maximum efficiency	92%
Maximum ac output power	100W
Rated ac power	86W
Rated ac off grid voltage	12V

D. Battery Back up

The battery make is Exide Power plus, Lead-acid battery is shown in Fig.5 and has following ratings



Fig 5. Exide Power plus, Lead-acid battery

- Each Battery rating : 26 Ah
- Total Number of batteries: 01
- Total Capacity : 26Ah
- Battery Voltage : 12V

E. Daily House Hold Consumptions

- Total daily house hold energy needed = 108 Wh/day
- Total monthly house hold energy needed =3.2 KWh/month

V REAL TIME RESULTS OF 30Wp OFF GRID SOLAR PV PLANT

The real time readings of 30Wp off grid solar PV module are recorded on 18/05/2017 at 11.30AM at Hyderabad city, INDIA. The output meter readings are tabulated in Table 3 and the recorded readings can be observed from multi meter in Fig.6.

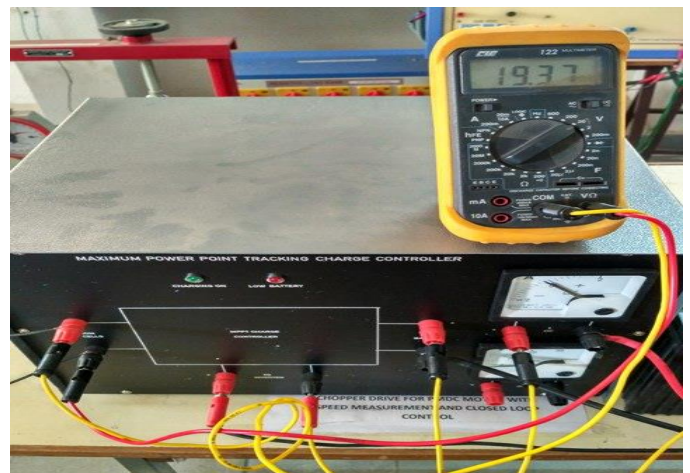

Fig.6. Experimental set up of 30WP off grid Solar PV Module

Table3. Output meter readings of 30WP off grid Solar PV module on 18/05/2017 at 11.30AM

Voltage(V) in Volts	Current(I) in Amperes
19.37	0
19.32	0.2
19.26	0.3
18.8	0.5
18.4	0.9
16.78	1.2
0.9	1.9

The V-I characteristics of 30Wp Solar PV module is shown in Fig.7

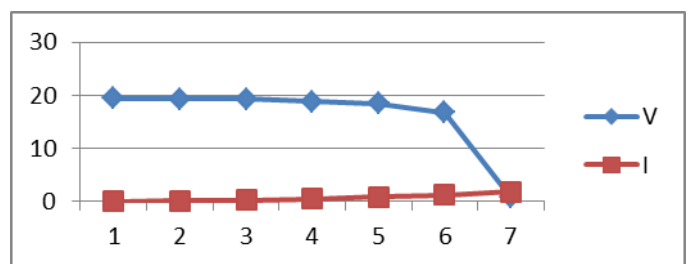

Fig.7 The V-I characteristics of 30Wp Solar PV module

VI SIMULATION ANALYSIS RESULTS 30Wp OFF GRID SOLAR PV PLANT

For simulation purpose, the considered PV module capacity is 30WP, 15V Si-Poly with array current of 1.7A from Van De Loo. The Considered battery capacity is 42Ah, 12V with stored energy of 0.5KWh from MK Battery. Due to non-availability of correct make, it is considered from other manufacturers with appropriate ratings. The global system configuration of the PV array is shown in Fig.8

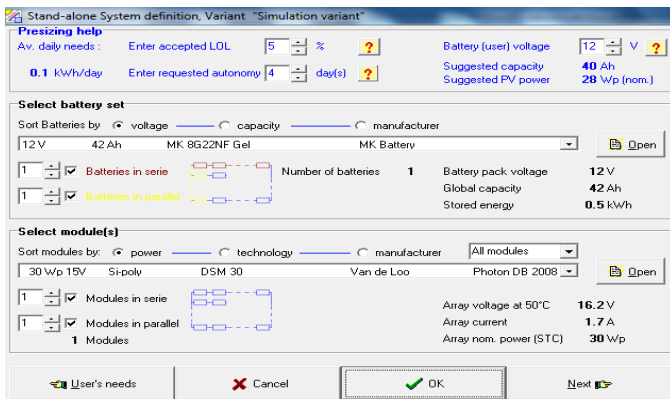

Fig.8 The global system configuration of the PV array

The mateo for Hyderabad, synthetic data is shown in Fig. 9

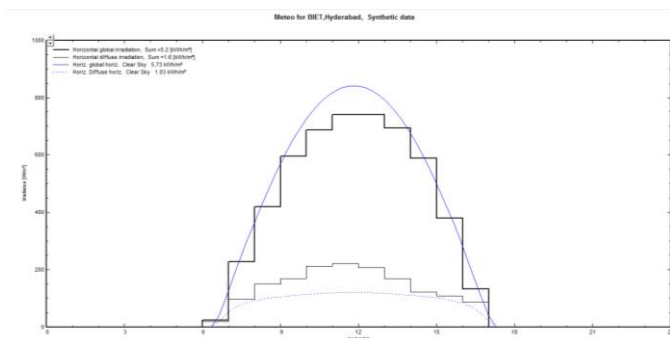

Fig.9 Mateo for Hyderabad city.

The solar paths at Hyderabad city is shown in Fig 10

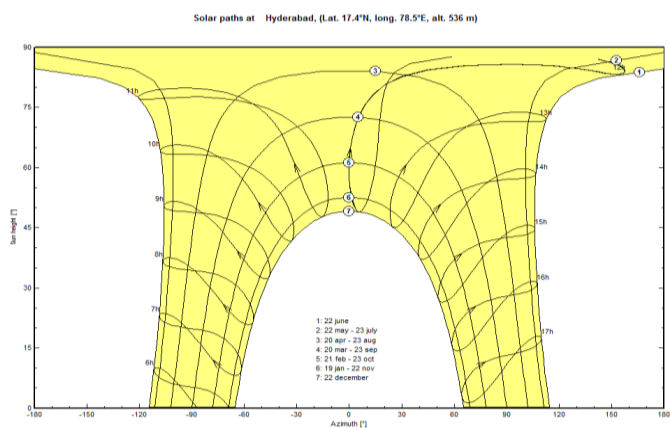

Fig.10 Solar paths at Hyderabad City .

The simulation input and the main results of standalone 30WP project are shown in Fig.11

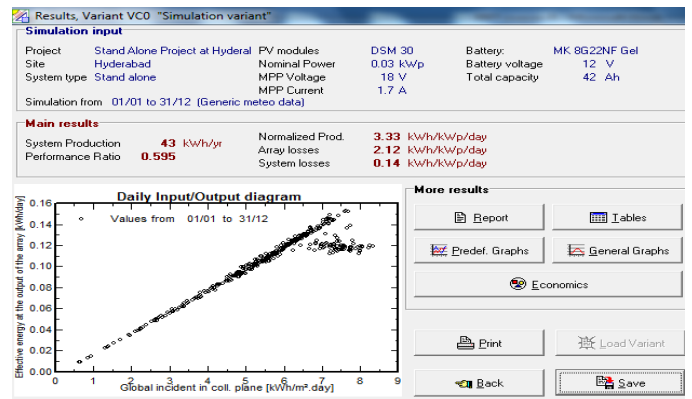

Fig.11 The simulation input and the main results of standalone 30WP project

From main results, the 30Wp PV system production is 43KWh/year with performance ratio of 0.595. The array losses are 2.12 KWh/KWp/day and system losses will be 0.14KWh/KWp/day. The simulation input parameters for Nominal Power 0.03KWp (30Wp); Maximum Power voltage is 18V and Maximum power current is 1.7A. The battery capacity is 42AH, 12V.

The normalized productions in KWh/KWP/day for 30WP project are shown in Fig.12

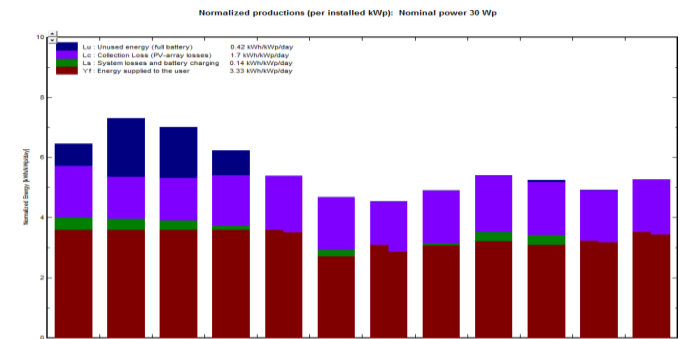

Fig.12 The normalized productions in KWh/KWP/day for 30WP project

From the normalized productions for 30Wp solar PV; the unused energy is 0.42KWh/KWp/day, PV-array losses are 1.7KWh/KWp/day and energy supplied to the user is 3.33KWh/KWp/day.

The Global irradiation and array energy output and unused energy/day are shown in Fig.13

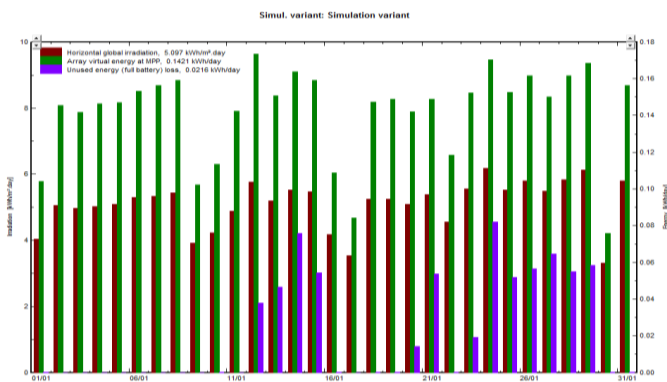

Fig.13 The Global irradiation and array energy output and unused energy/day

The horizontal global irradiation is 5.097 KWh/m².day, array virtual energy at Maximum peak power is 0.1421KWh/day and unused energy loss is 0.0216 KWh/day.

The Main Simulation results of 30WP Project are given in Table 4.

Table 4 Main Simulation results of 30WP Project

Simulation variant Balances and main results								
	GlobHor	GlobEff	E Avail	EUnused	E Miss	E User	E Load	SolFrac
	kWh/m ²	kWh/m ²	kWh	kWh	kWh	kWh	kWh	
January	158.0	195.6	4.405	0.670	0.002	3.346	3.348	0.999
February	173.0	199.6	4.956	1.630	0.003	3.021	3.024	0.999
March	208.0	211.0	5.199	1.564	0.003	3.345	3.348	0.999
April	203.0	180.5	4.090	0.721	0.002	3.238	3.240	0.999
May	199.0	160.8	3.267	0.002	0.000	3.348	3.348	1.000
June	172.0	134.4	2.650	0.002	0.782	2.458	3.240	0.759
July	167.0	134.8	2.680	0.001	0.456	2.892	3.348	0.864
August	170.0	146.2	2.938	0.000	0.484	2.864	3.348	0.855
September	166.0	157.0	3.183	0.001	0.341	2.899	3.240	0.895
October	150.0	158.0	3.242	0.051	0.458	2.890	3.348	0.863
November	126.0	143.6	2.869	0.000	0.329	2.911	3.240	0.899
December	129.0	159.2	3.206	0.000	0.052	3.296	3.348	0.984
Year	2021.0	1980.7	42.685	4.643	2.914	36.506	39.420	0.926

VII. CONCLUSIONS

The real time monitoring and performance evaluation of 30WP solar PV power plant located on the roof of a residential building in Hyderabad city is carried out by building a hardware model of 30 WP solar roof top PV plant and by simulating 30WP plant using PV syst Software. From the simulation results, the horizontal global irradiation is 5.097 Kwh/m².day in different months in a year and the available PV module energy at inverter output is 0.1421 Kwh /day or 2.65 to 5.19 KWh/month and energy demand is 0.11Kwh/day or 3.0 to 3.48 KWh/month. In Jan-April, the PV module output is more than the load demand so we get excess energy in these months and in remaining months PV module output is equal to or slightly more than the demand. The energy demand is 3.346KWh/month in Jan month while energy output of PV module is 4.405 KWh/month and excess energy is 0.670 KWh / month. These outputs of PV module vary with respect to irradiation. The future growth can be enhanced to larger scale PV modules.

REFERENCES

- [1] Hemakshi Bhoje. & Gaurang Sharma. (2014). An analysis of one MW photovoltaic solar power plant design. International Journal of Advanced research in Electrical, Electronics and Instrumentation Engineering, 3(1), 6969-6973.
- [2] Jasim Abdulateef., (2014). Simulation of solar off-grid photovoltaic system for residential unit. International Journal of sustainable and green Energy,4(3-1), 29-33.
- [3] Jayanna Kanchikere., & Kotresh k., & K., KalyanKumar. (2016). A 5KW photovoltaic solar roof top power plant design: An analysis. International Journal of engineering science and computing, 6(4), 4501-4504, <http://dx.doi.org/10.4010/2016.1032>
- [4] Jayanna Kanchikere., & K., KalyanKumar. (2016). Estimation of cost analysis for 5KW grid connected solar roof top power plant: A case study. International Journal of engineering science and computing, 6(4), 4505-4507, <http://dx.doi.org/10.4010/2016.1033>
- [5] Jayanna Kanchikere., & K.Kalyankumar, & Rajangam Kannan.(2017).Simulation analysis of 8KW grid connected solar roof top photovoltaic power plant in Davangere using PV syst, International journal of renewable energy and environment engineering, 05(01), 45-52 , 2017
- [6] Radhey S M., & Jeetendra Singh Rathore., & Shivani, J. (2014). Grid connected roof top solar power generation: A review. International Journal of Engineering development and research, 3(1), 325-330.
- [7] Vinay Janardhan shetty & Keerti Kulkarni. (2014). Estimation of cost analysis for 500KW grid connected solar Photovoltaic plant: A case study. International Journal of current engineering and technology, 4(3), 1859-1861.
- [8] <http://eosweb.larc.nasa.gov/sse>